

Thermal Receipt Printer User's Manual

OCKP-801

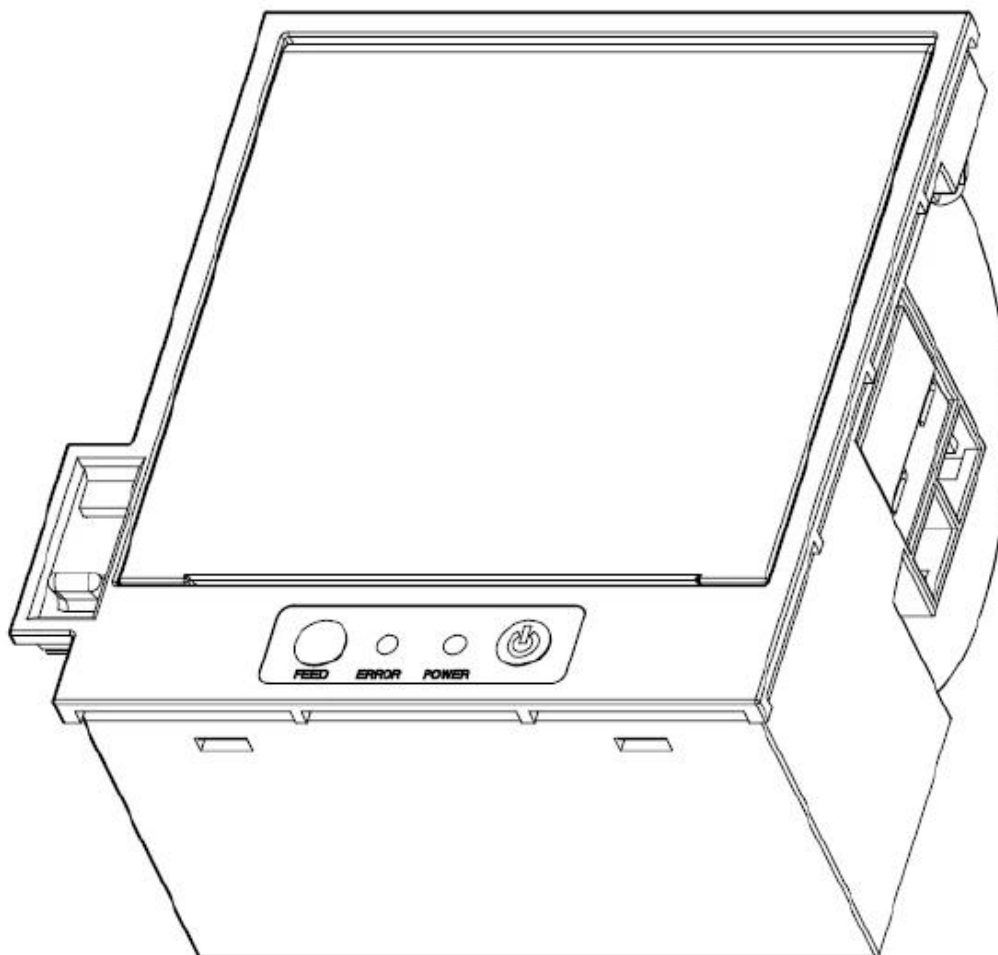

Content

| | |
|---|-----------|
| Content | 1 |
| Introduction | 2 |
| Chapter 1 Feature and Performance | 2 |
| 1.1 Print Performance | 2 |
| 1.2 Print Paper | 2 |
| 1.3 Print Font | 3 |
| 1.4 Interface | 3 |
| 1.5 Print Control Commands | 3 |
| 1.6 Power Supply | 4 |
| 1.7 Operation Environment | 12 |
| 1.8 Outline Dimension | 12 |
| Chapter 2 Operation Specification | 13 |
| 2.1 Printer Appearance | 13 |
| 2.2 Installation of the printer | 15 |
| 2.3 Paper Installation | 16 |
| 2.3.1 Paper Loading | 16 |
| 2.3.2 Solution to Paper Jam | 16 |
| 2.4 Interface | 17 |
| 2.4.1 Serial Interface | 17 |
| 2.4.2 USB interface | 19 |
| 2.4.3 Power Connection | 19 |
| 2.5 Buttons and Indicators | 19 |
| 2.6 Turn on the printer | 21 |
| 2.7 Self test | 21 |
| 2.8 Hexadecimal Printing | 22 |
| 2.9 Setup of printer parameter | 23 |
| 2.10 Entering program upgrading mode | 23 |
| APPENDIX A: Parameters Setting | 23 |

Introduction

OCKP-801 printer is a new type line thermal printer, which features in fast speed print, low print noise, high reliability, perfect print quality and ribbon needless, avoiding the vexation of regular maintenance.

Chapter 1 Feature and Performance

1.1 Print Performance

- Print method: direct thermal
- Print paper width: $79.5\pm 0.5\text{mm}$
- Print density: 8 dots/mm, 576 dots/line
- Print speed: max 170mm / sec.
- Reliability
 - (1) Print head life: 100km
Using condition:
 - * Print 12×24 ANK characters, print 50 lines each time, intermittent print repeatedly
 - * Use specified thermal paper
 - (2) Cutter life: 700,000 cuts
Using condition: less than 30 cuts/minute
- Valid print width: 72mm

1.2 Print Paper

- Thermal paper roll model: TF50KS—E (Japan paper co.ltd)
AF50KS-E (JUJO THERMAL)
- Thermal paper roll: Width — — — $79.5\pm 0.5\text{mm}$
Outer Diameter — — — 80mm (max.)

Inner Diameter — — — 13mm (min.)
Thickness — — — 0.06mm~0.08mm

1.3 Print Font

- ANK Character Set
12×24 dots, 1.5 (W) ×3.00 (H) mm
- GB18030(Chinese):
24×24 dots, 3.00 (W) ×3.00 (H) mm.

1.4 Interface

- RS—232C Serial Interface:
IDC10 socket, supports XON/XOFF and DTR/DSR protocols.
Baud rate:1200, 2400, 4800, 9600, 19200, 38400, 57600, 115200bps
adjustable。
Data structure: 1start bit + (7 or 8) data bits + 1 stop bit.
Parity checking: no parity or odd, even parity optional.
- USB Interface:
Mini USB interface

1.5 Print Control Commands

- Character print commands: support double-width, double height print of ANK characters, user-defined characters and Chinese characters, the character line spacing is adjustable.
- Graphics print commands: support the print of bit-map graphics and download bit-map graphics with different density
- GS bar code print commands: support UPC-A, UPC-E, EAN-13, EAN-8, CODE39, ITF, CODEBAR, CODE93, CODE128,PDF417,QR code, DATA Matrix bar code print.

1.6 Power Supply

- DC24V±10%, 2A, 2114s-02 power socket.

1.7 Operation Environment

- Operation temperature: -10~50℃; Operation humidity: 10~80%
- Storage temperature: -20~60℃; Storage humidity: 10~90%

1.8 Outline Dimension

Pls check outline dimension in the below picture 1-1:

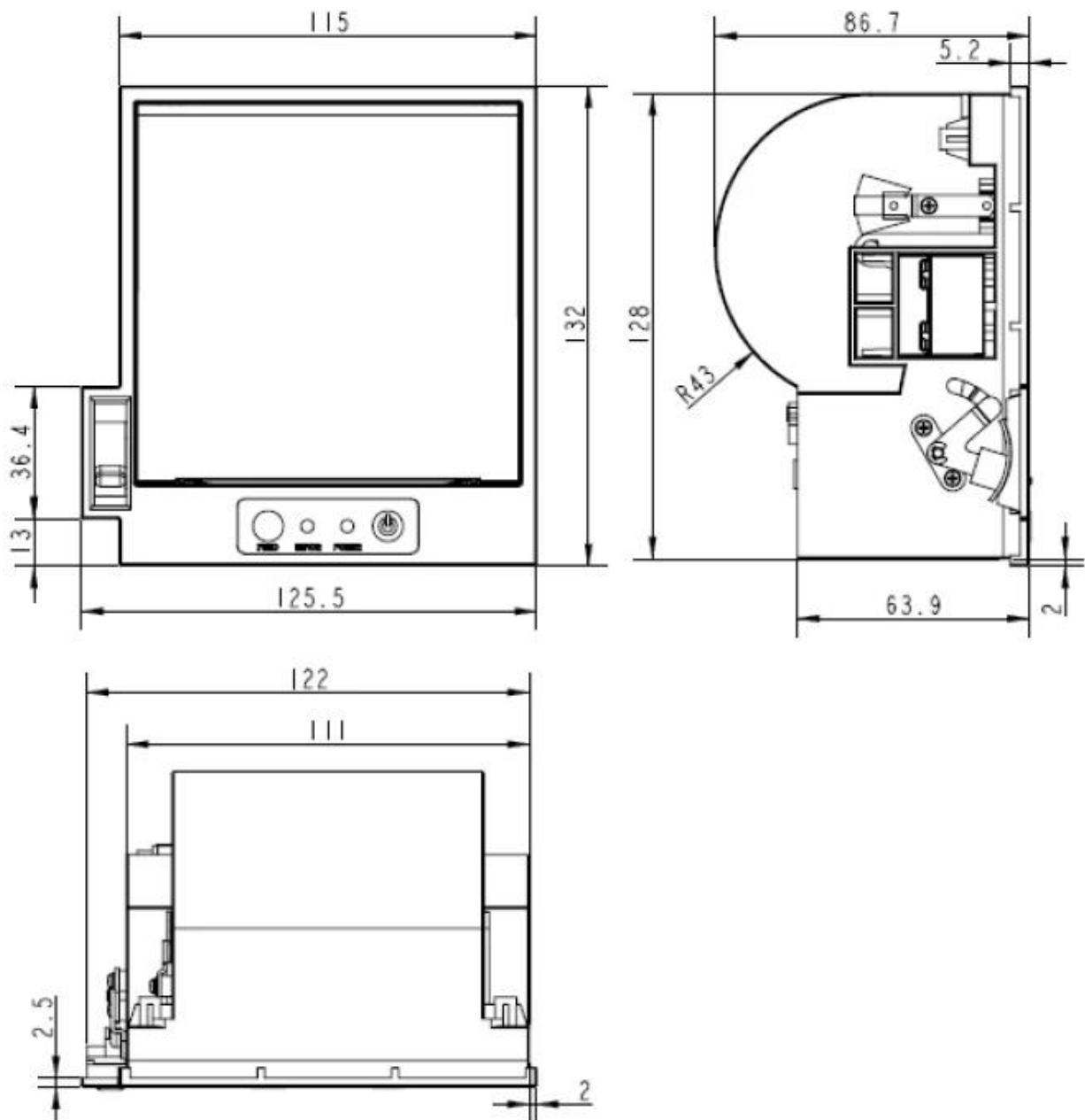

Fig.1-1

Installing hole dimension of customer's panel, as picture 1-2:

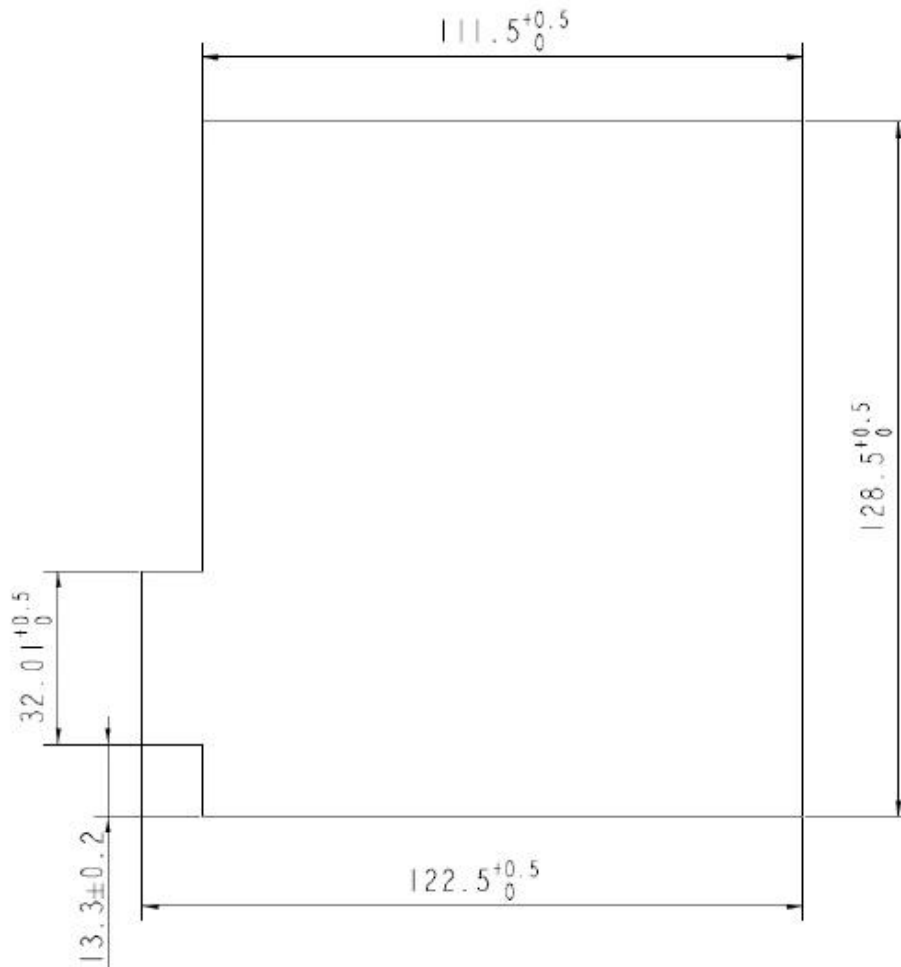

Fig.1-2

Chapter 2 Operation Specification

2.1 Printer Appearance

About the name of each part of printer, pls refer to picture 2-1:

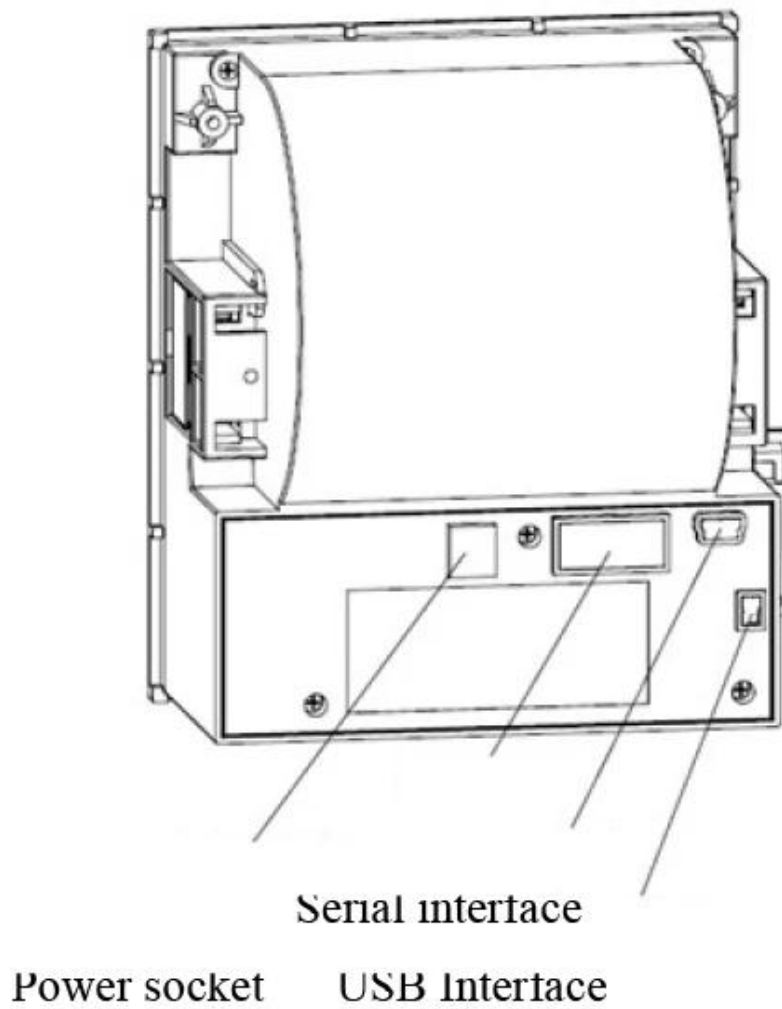
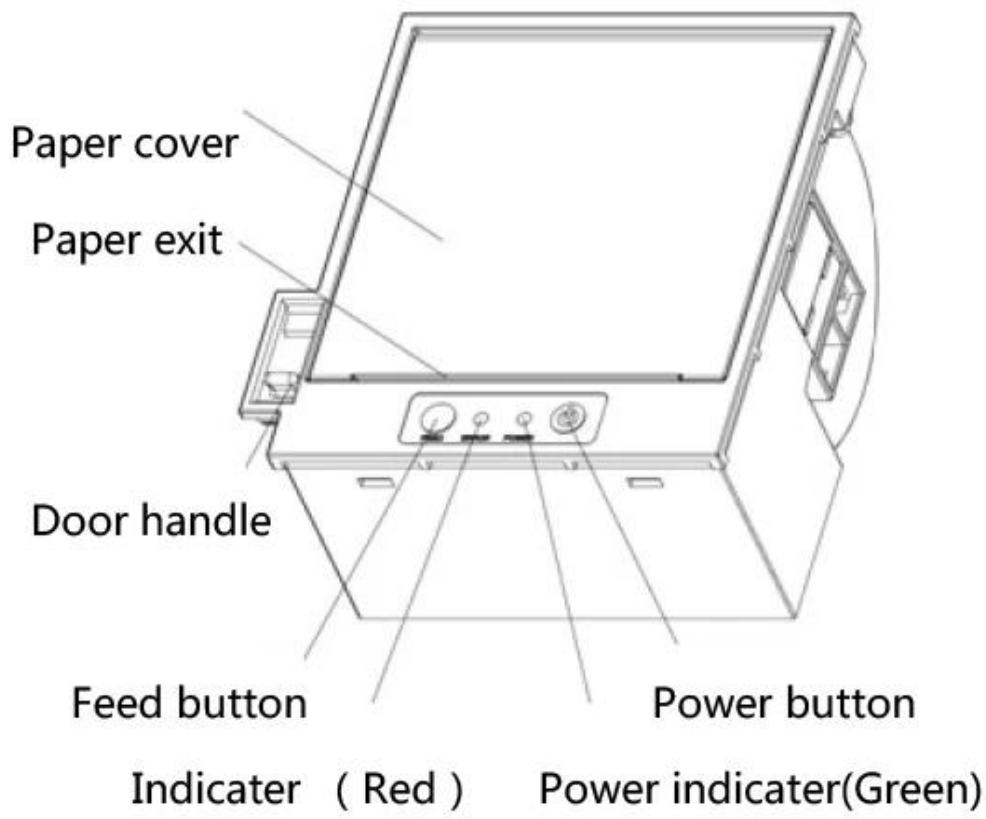
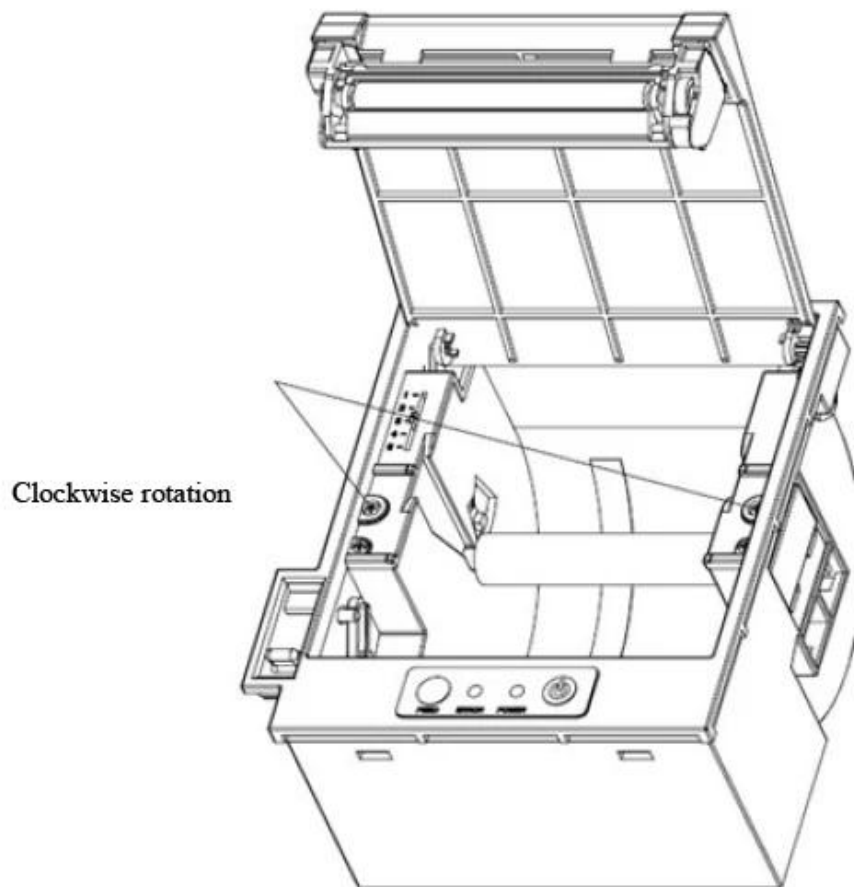

Fig.2-1 Printer Appearance

2.2 Installation of the printer

Embedded printer in the installing hole of customer's panel. open the printer paper cover, clockwise to tighten the two screws to complete the installation of the printer . Print installation shown in Figure 2-2。



2.3 Paper Installation

2.3.1 Paper Loading

POS801 adopts $79.5\text{mm} \pm 0.5\text{mm}$ width thermal paper roll.

Steps of Loading Thermal Paper are as below:

Hold down the upper cover button on the left side, open the movable upper cover, draw a certain length of the paper roll, put the paper end on the print head, close the upper cover and press it downwards lightly.



1. Pay attention to the direction of loading paper, make the printing surface face to the print head.
2. Please don't feed or draw the paper forwards or backwards with hands.
3. Keep clean of the print head, avoid to influence the printing quality.

2.3.2 Solution to Paper Jam

If cutter is jam, turn off the power, and turn on again, the cutter will be back to original position. If paper jam, open the paper storage cover, and take out the paper. If the cutter can not be back to the original position after power on again, open the cover of paper case directly, the cutter will be back to

original position before the cover opening.

2.4 Interface

2.4.1 Serial Interface

The serial interface of SP-POS88I V printer is compatible with RS-232C, supports DTR/DSR and XON/XOFF handshaking protocols, uses IDC10 socket. The pin order of the serial port is as Fig.2-3 shows:

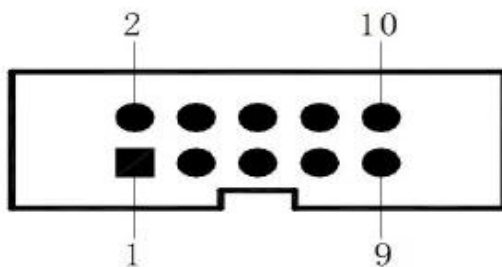

Fig.2-3 Pin Order of Serial Port

The pin assignment of serial interface is shown in Fig. 2-3:

| Pin No. | Signal Name | Signal Direction | Source | Description |
|---------|-------------|------------------|---------|--|
| 2 | DTR | Output | Printer | Signal "MARK" means the host is busy and can not receive data. Signal "SPACE" means the host is ready to receive data. |
| 3 | TXD | Output | Printer | Printer transmits control code X-ON/X-OFF and data to host |
| 4 | DSR | Input | Host | Signal "MARK" means the host is busy and can not receive data. Signal "SPACE" means the host is |

| | | | | |
|---|-----|--------|---------|---------------------------------|
| | | | | ready to receive data. |
| 5 | RXD | Input | Host | Printer receives data from host |
| 6 | RTS | Output | Printer | Same with Pin No.2 DTR Signal |
| 9 | GND | ----- | ----- | Signal Ground |

Fig. 2-3 The pin assignment of serial interface

Note: (1)“Source” denotes the source that signal come from;

(2)Logical signal level is EIA.

The baud rate and data structure in serial interface mode is 9600bps, 8-bit data bits, no parity bit and 1 stop bit. The serial interface of OCKP-801 can be connected to standard RS-232C interface. When it is connected to IBM PC or its compatible machine, connection can accord to Fig.2-4.

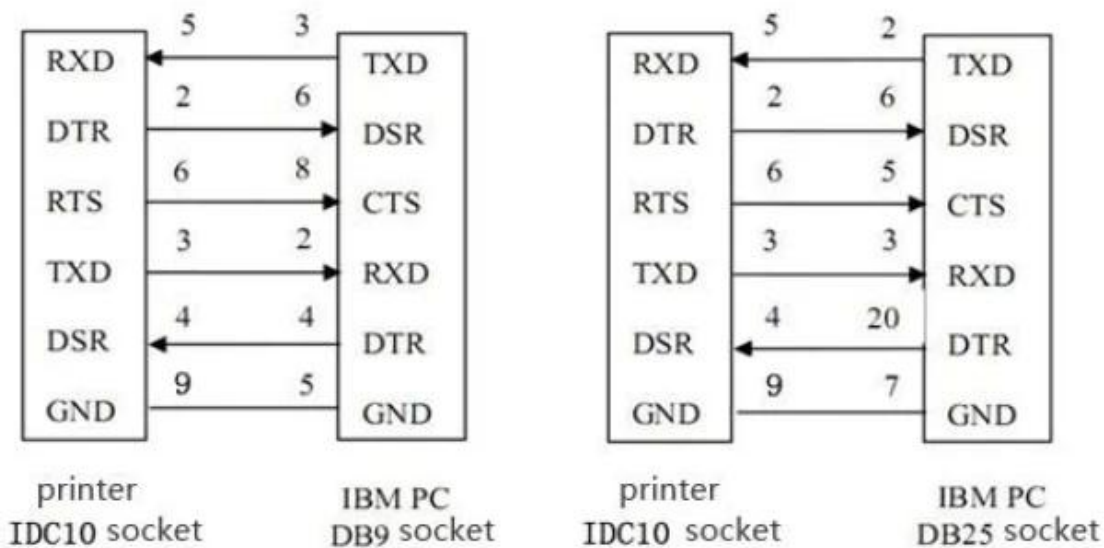

Fig.2-4 Connection between OCKP-801 and IBM PC Serial Interface

2.4.2 USB interface

The USB interface of the POS801 printer is mini-USB interface, outer appearance and pin assignment is shown in Figure 2-5:

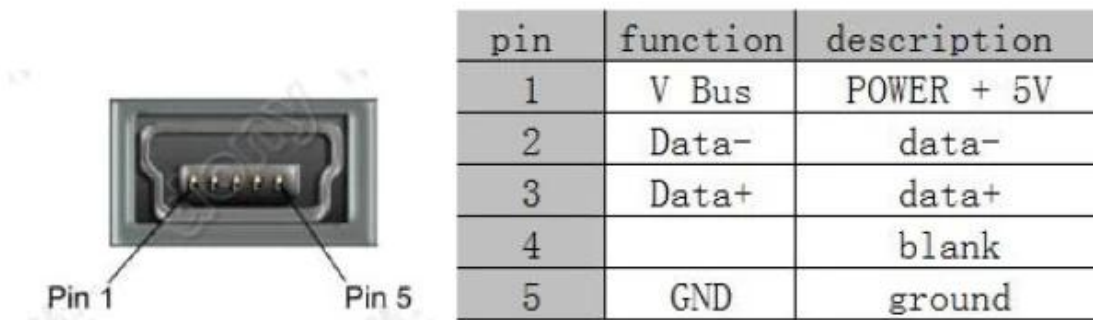

Figure 2-5; Mini-USB socket and pin definitions

2.4.3 Power Connection

OCKP-801 printer uses the external power supply adopter as $24V \pm 10\%$ 、2A, power socket is 2114S-02 model, as Fig. 2-6 shows:

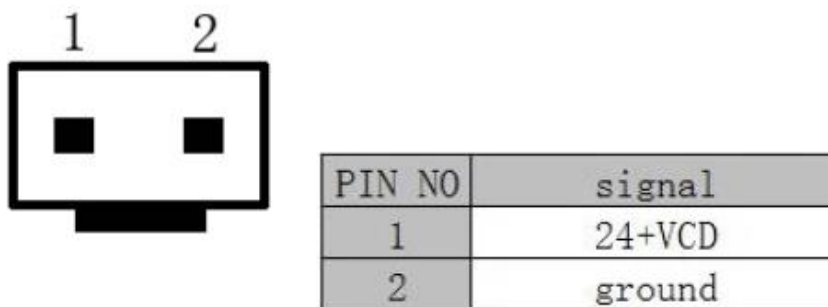

Fig.2-6 Power Socket

2.5 Buttons and Indicators

There are two buttons, one inner buzzer and two indicators for POS801.

【POWER】 is power button. When printer is off, press **【POWER】** button for one

second, the buzzer will sound, then release **【POWER】** button. Printer gets into the normal working status. When the printer is on, press **【POWER】** button for one second, the buzzer will sound, then release **【POWER】** button. Printer is powered off.

【FEED】 is paper feed button. The function of this button is on/off can be set by print command. When the function of this button is on, press **【FEED】** button to feed paper; release **【FEED】** button to stop feeding button.

The buzzer can indicate the error and cutter status. Through parameters setting, the buzzer can be set into error alarm, paper-cut indicating or both above. The types of error status are same as ERROR indicator.

The green POWER light is the power indicator. POWER indicator lighting means the printer is power on.

The red ERROR light is error status indicator. It is off when the printer works normally; while it flashes or persismently lights when the priner has abnormal alarm.



If ERROR indicator flashes or persisment lights and the buzzer sounds, it means the printer has error.



According to different flashing types, the different errors of printer are indicated:

1. Un-recoverable error: the times of indicator flashing and buzzer sound indicate the error type, then indicator persismently light.
2. Recoverable error: the times of indicator flashing and buzzer sound indicate the error type, then indicator is persismently off.
3. Automaticly recoverable error: the indicator flashes and the buzzer sounds continuously.
4. Paper out: the indicator lights and the buzzer sounds persismently.

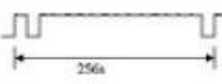
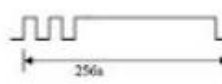
The details are as below,

- a. Un-recoverable error, the indicator flashes several times, then persismently lights. Then cycle. The times of flashing means the error type.

| Error type | Description | Types of ERROR flashing |
|----------------------|---|--|
| Un-recoverable error | LED flashes once : Memory read - write errors |  |
| | LED flash twice: Over-voltage |  |
| | LED flashes three times: the voltage is lack |  |
| | LED flashes four times : CPU Execution error (wrong |  |

| | | |
|--|---|---|
| | addression) | |
| | LED flashes five times : UIB error |  |
| | LED flashes eight times : temperature detection of circuit is wrong |  |

b. Recoverable error: the indicator continuously flashes and persistent off for a period.

| Error type | Prescription | Type of flash |
|-------------------|--|---|
| Recoverable error | LED flashes once .the place of cutter is wrong |  |

c. Automaticly recoverable error: the indicator flashes continuously.

| Error type | Description | Type of flash |
|-------------------------------|---|---|
| Automaticly recoverable error | LED continues flashing : the temperature of printing head is over high and the cover is wrong |  |

2.6 Turn on the printer

When the printer is off and paper case cover is closed, press the POWER button to turn on the printer and the ERROR indicator flashes twice, then indicator off. The printer enters into the normal working mode.

2.7 Self test

The self-test will check the condition of printer, if the printer prints out the self-test receipt correctly, it means the printer works normally except interface with host. Otherwise it needs to repair.

The self-test will print out: Manufacturer name, printer model, software version, interface type, default value of printer parameters, 96 ANK characters in ASCII code, content of default codepage (if language is set English) or name of Chinese character library (if the language is set Chinese), barcode

type, at last four lines black and white alternating icon.

Way of self-test: hold down【FEED】button and press【POWER】button to turn on the printer, after buzzer sounds, release 【POWER】 button firstly, then release 【FEED】button. At this time, printer will print out self-test receipt. The content is as below picture 2-7:

```
*** Self Test ***  
Manufacturer: SPRT  
Model: POS88VI  
Version: R-906 L1.00  
Interface: Parallel  
Language: Chinese  
PrintFont: 12*24  
PrintWidth: 64mm  
PrintDensity: Medium  
PrintSpeed: 200mm/s  
AutoCut: Yes  
BuzzerEnable: Error ON  
NoPaperReprint: ON  
BlackMark: OFF  
PaperSensor: Medium  
PrintDierction: Normal  
Command System: ESC/POS  
CodePage: CP437  
打印 ASCII 字符 0x20----0x80 处得 ascii 字符  
GB18030 汉字库  
Barcode Type  
1D: UPCA,UPCE,EAN13,EAN8,CODE39  
ITF25,CODABAR,CODE93,CODE128  
2D: PDF417,QR,CODE,DATA Matrix  
■■■■■■■■■■■■■■■■■■■■■■■■■■■■■■  
■■■■■■■■■■■■■■■■■■■■■■■■■■■■■■  
■■■■■■■■■■■■■■■■■■■■■■■■■■■■■■  
■■■■■■■■■■■■■■■■■■■■■■■■■■■■■■  
*** Completed ***
```

Fig. 2-7

2.8 Hexadecimal Printing

Turn on the printer according to the step below, it will enter the mode of Hexadecimal Printing

- 1.Open the cover;
- 2.Hold down 【POWER】 button to turn on the printer
- 3.Close the cover, the printer will print out 3 lines as below:

Hexadecimal Dump

To terminate hexadecimal dump,
Press FEED button three times.

This means the printer has entered hexadecimal printing mode, and under this mode,all of the input will be printed out as hexadecimal number. Paper will

feed one line with single-click of “FEED” button, after 3 times, it will print out “*** Completed ***” , and exit hexadecimal printing mode.

2.9 Setup of printer parameter

This function is for the setup of parameters.

Steps for setting parameters: Power off , open 【Printer Roller】 and press the【FEED】 button at the same time; release the 【FEED】 button after light flashing ; then press the 【FEED】twice and close the【Printer Roller】; printer is in the parameter setting mode . Print the first parameter which can be set and its current setup; Details can be seen according Appendix.

Steps for exiting of parameter setup: open 【Printer Roller】 and press the 【FEED】 button; then close the【Printer Roller】, release the 【FEED】 button and save the setup of parameter and exit ;enter the normal mode ;the date will not saved if turn off the printer just through pressing 【FEED】 button.

2.10 Entering program upgrading mode

When printer power is off, open paper case cover, hold down the 【FEED】 button, then press 【POWER】 button and turn on the printer. After hearing the buzzer “one low one high” sound, release 【POWER】 button. Printer enters into the program upgrading mode. At this time, the indicator flashes once each second.

Notice: Both serial interfacen and USB interface can support programm upgrading online.

APPENDIX A: Parameters Setting

This appendix is the method of setting default parameters of printer by buttons.

Setting instruction: Using button for paper case cover to choose setting item. Pressing this button once, the setting item will go to the next and also print out the current value of this item. Using 【FEED】 button to choose the setting value of item. Press the button once, the setting value will go to the next.

Summary setting:

| |
|----------|
| Font Dot |
|----------|

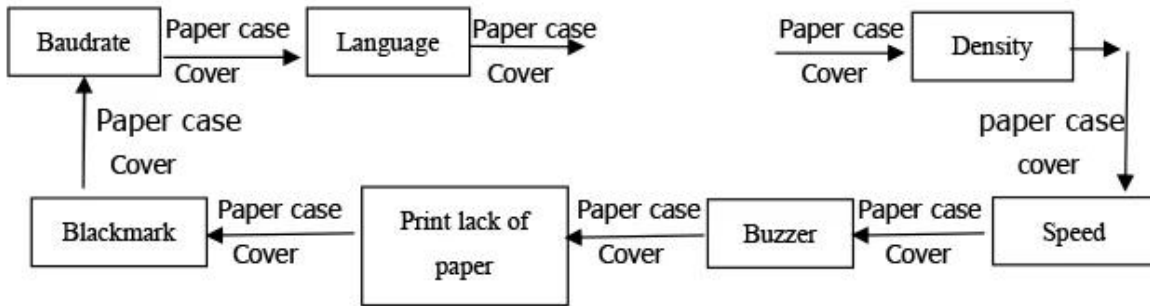

Baudrate:

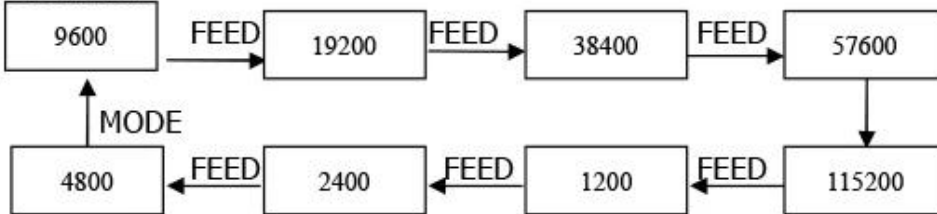

Language:

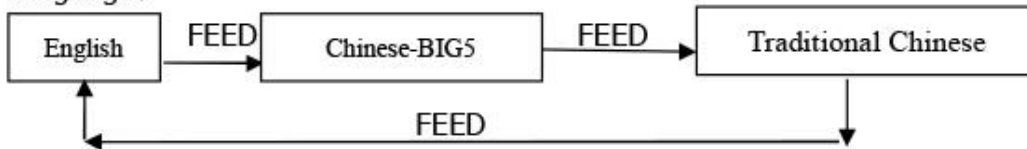

Font:

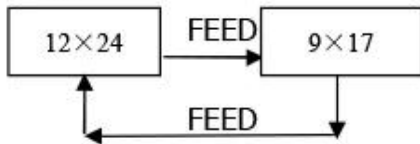

Density:

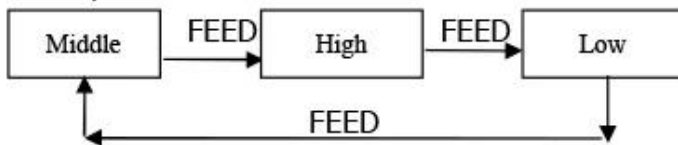

Buzzer:

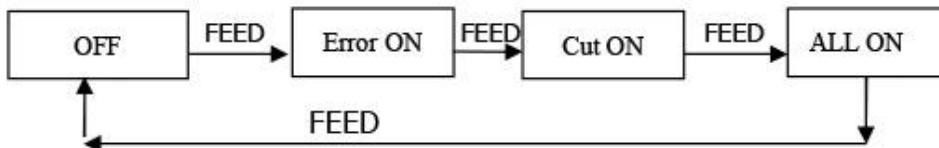

Print lack of paper:

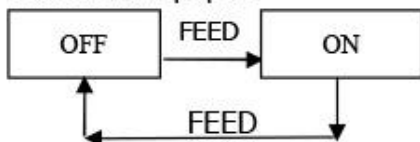

Blackmark:

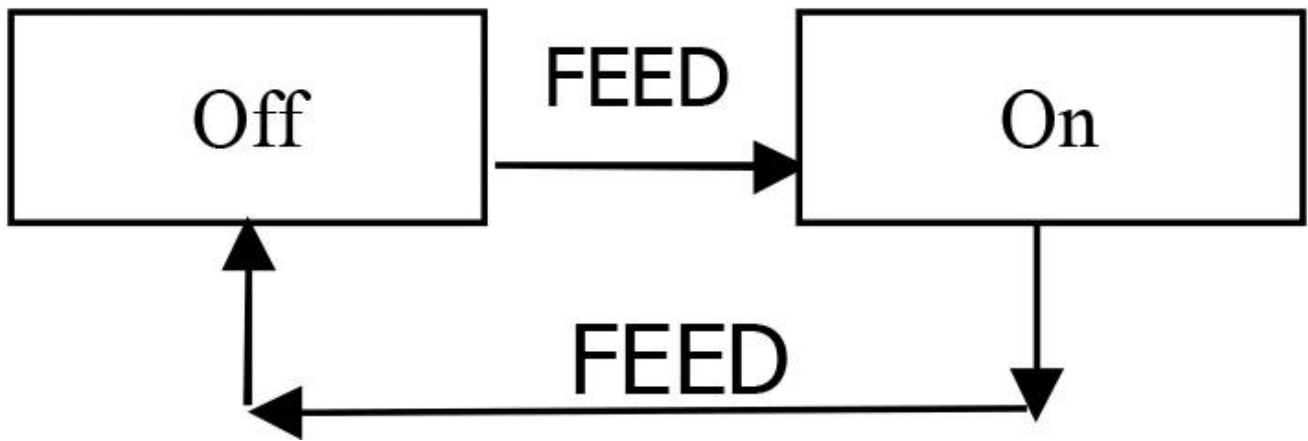

FAQ

1. MOQ-Richtlinie

Keine MOQ-Einschränkung für die Standardprodukte, aber der Stückpreis ist anders, größere Mengen besserer Preis.

Für eine individuelle Produktion können Sie das MOQ direkt mit unserem Vertriebsmitarbeiter besprechen.

2. Musterverfügbarkeit & Politik

Nachdem die Kunden die Spezifikation bestätigt haben, freuen wir uns, Muster zur Prüfung und Qualifizierung zur Verfügung zu stellen.

Alle Muster sollten vor dem Versand bezahlt werden, der Musterpreis ist höher als die Massenbestellung. Wenn die Massenbestellung aufgegeben wurde, können wir Ihnen die Musterkosten zurücksenden oder Ihnen weitere Stückprodukte mit den Versandstücken zusenden.

Sie können die Muster bei uns direkt mit t / t, Western Union oder paypal kaufen. Und Sie können es auch in unserem Online-Shop kaufen.

3. Gewährleistung

OCOM bietet kosteneffiziente Produkte und Dienstleistungen mit zuverlässiger Qualität, die die Zufriedenheit der Kunden erfüllen.

Wir wurden vom globalen Fortune-500-Unternehmen qualifiziert, und wir verfügen über die höchste Handelssicherheitsstufe, die Ihr Geld und Ihre Vorlaufzeit zu 100% schützt.

Unsere garantie der produkte beträgt ca. 12 + 1 monate ab dem versand normalerweise, einige designierte modelle können bis zu 24 monate garantie haben;

Jedes Produkt, das innerhalb von 30 Tagen nach dem Ausfall der Lieferung auftritt, gilt als ungültige Lieferung (DOA). DOA-Produkte geben dem Austausch Priorität und werden per Kurier versandt.

Für die Massenbestellung möchten wir einige Ersatzteile mit Versand für eine schnelle Reparatur vor Ort liefern. Danach können Sie defekte Teile zur Nachbearbeitung und Analyse zurücksenden.

4. Zahlungsbedingungen

Für Massenbestellungen können Sie uns mit T / T, LC, Western Union, Escrow oder anderen bezahlen. Über Probenauftrag, T / T, Western Union, Übertragungsurkunde, Paypal sind annehmbar. Momentan können Sie mit Moneybookers, Visa, MasterCard und Banküberweisung bezahlen. Sie können auch mit ausgewählten Debitkarten wie Maestro, Solo, Carte Bleue, Pos tePay, CartaSi, 4B und Euro6000 bezahlen.

5. Versand

Wir akzeptieren alle Arten von Versandarten, einschließlich: Express, Luft, See, LKW oder Abholung durch Kunden persönlich.

6. Kunde

Unsere Hauptkunden aus European, Australien und dem schnell wachsenden Südamerika, Afrika, Russland ...,

Wir haben über 2200 Kunden aus 159 Ländern betreut, darunter das globale Fortune-500-Unternehmen wie Unilever, O2 50 von ihnen sind der größte Distributor in den lokalen Territorien.

Warum wählen Sie OCOM?

- Führender Anbieter von POS- und Auto-ID-Produkten aus einer Hand, der von globalen Fortune-500-Unternehmen qualifiziert ist
- Tier-1-Kunden wie Unilever, O2, Star ...
- 2200 + Kunden decken 159 Länder ab;
- 9 Jahre OEM / ODM-Erfahrung.
- Top-1-Level-Handelssicherung in POS-Qualitätsgarantie für Qualität und Versanddatum
- Schnelle Antworten und professioneller Service
- ISO, FCC, CE, Soncap, POA, BIS und andere Zertifikate
- 12 + 1 Monate Garantie.
- In der "China Best Employer Award" nominiert
- Glaube: Integrität, Streben nach Exzellenz, Win-Win-Kooperation

Firmeninformation

OCOM Technologies Ltd. ist der Hauptlieferant und Hersteller von POS- und Auto-ID-Produkten, wobei der TÜV geprüft wurde.

Das Produktportfolio von OCOM umfasst Thermodrucker, Barcodedrucker, Nadeldrucker, Barcodescanner, POS-Terminal, Magnetkartenleser, Datumsterminal und andere POS-Peripheriegeräte (Kassenschublade, Kundendisplay, POS-Monitor, POS-Tastatur, Geldzähler, Elektronische Waage, Thermopapier), die häufig für den Einzelhandel, Restaurants, Banken,

Lotterien, Transport, Logistik und andere Anwendungen verwendet werden. Wir haben CE-, FCC- und andere erforderliche Zertifizierungen.

Die Mission von OCOM ist es, die überzeugende Wahl für unsere Partner zu sein, und unsere drei Grundüberzeugungen lauten "Integrität, Streben nach Exzellenz, Win-Win-Kooperation". Wir möchten stabile und zuverlässige Partnerschaften mit Kunden auf der ganzen Welt eingehen. OEM / ODM ist willkommen.

Gemeinsam suchen wir nach dem Besten.

OCOM Technologies Limited.

Adresse: 4 / F, Block 10, Zhongxing Industrial Park, Chuangye-Straße, Nanshan Shenzhen 518054, China;

Website: www.ocominc.com, www.posolution.com.cn;

E-Mail: richard@ocominc.com, richard@ocomtech.com.cn;

Geschäftsmanager: sz ocom inc.

Skype: ocom inc2000;

MSN: ocomtech@hotmail.com;

QQ: 2485890637;

Wechat: hj34924238;

Whatsapp: 0086.133.52932860;

Mobile: 0086.133.52932860;

Tel: 0086.755.86053207, Durchwahl 808;

Fax: 0086.755.86053207, Durchwahl 868;

* Zuverlässiger POS-Lieferant für alle relevanten Produkte, der globale Fortune-500-Kunden bedient *